

P 200 A-R SMART

**COMPACT DESIGN
AND QUICK
AND EASY TO USE**

LIFETIME EXCELLENCE



STRENGTHS

- Lightweight and compact double articulated aerial platform for work in tight spaces, mounted on a 3.5 t truck. The double pantograph unit guarantees great versatility and the ability to move over in elevated positions.
- User-friendly hydraulic controls
- Single stabilisation system for quick positioning
- All metal structural work features cathodic electrodeposition coating, with KTL system patented by PALFINGER.

STANDARD











- 230V / 16A socket A or 110V / 16A 12V socket on basket
- Aerial section centring display for aerial part closing
- Air/water line from the column to the basket
- Electric hour meter
- Top boom protection
- Cage rotation 90°+ 90°
- Mechanical anti-collision system cab/boom
- Painting with cathaphoresis process, with KTL system patented by PALFINGER
- Spreader plates with proper housing on the chassis 12V socket on basket.

MAIN ACCESSORIES

- 12V electric pump for emergency lowering
- 230V / 16A or 110V / 16A electric pump with quick coupler
- Brushes kit on telescopic boom
- Fiberglass basket (replacement for aluminium cage)
- 1000V insulation on fibreglass basket
- Flashing light at turntable
- Folding left and right side bordering h = 200mm
- Inclinator with audio alarm signal and signal lights relating to aerial work conditions
- Plastic storage toolbox at the rear
- Side protection.



TECHNICAL DATA

	Max. working height	19.6 m		Basket rotation	2x90°
	Max. working height from platform deck	17.6 m		Basket dimensions	m 1.4 x 0.84 x 1.1 h
	Max. working outreach	8.2 m		Max. load permitted on basket	230 kg
	Outrigger width	2.5 m		Stabilization	4, "A"-shaped, direct descent outriggers
	Operating angle of main arm	-25°/+73°		Gross vehicle weight	3.5 t
	Turret rotation	380°			

WORK AREA

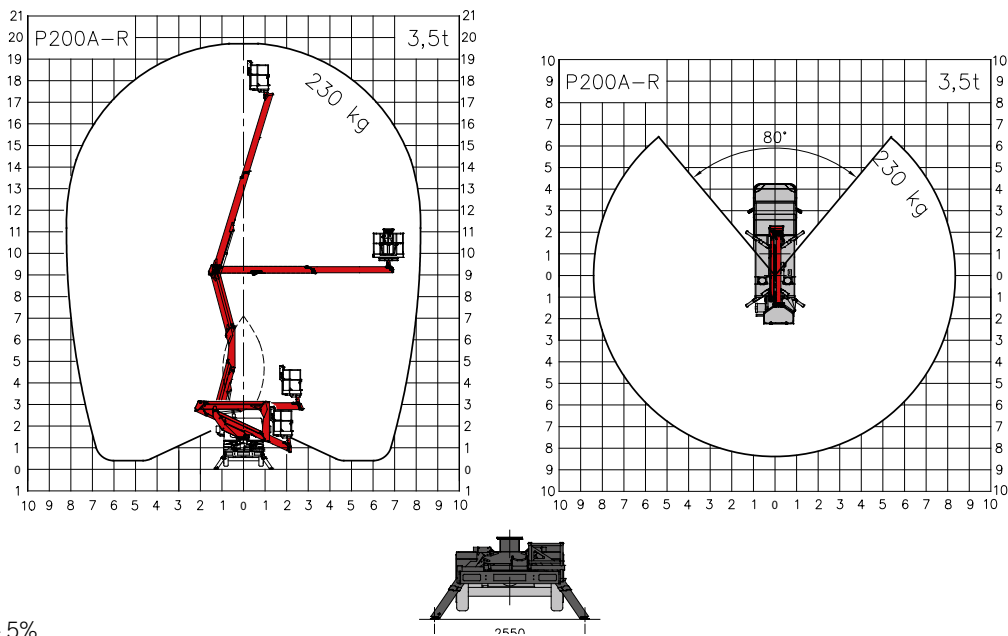

Weights may vary by +/- 5%
 Technical data may vary by +/- 3%

DIMENSIONS



CONTACT DETAILS**PALFINGER PLATFORMS ITALY SRL**

Via Enrico De Nicola, 31
41122 Modena (MO) - Italy
TEL: +39 059 252426
EMAIL: info@palfingerplatformsitaly.it

KP-P200ARM1+EN

The illustrations in the brochure may show units equipped with optional accessories and not always the standard version. National legislation must be complied with during construction/assembly. The dimensions stated are not binding. The company cannot be held responsible for any changes in technical information, inaccuracies, or translation errors.