

LL26.14 MK2

CAPACITY 230 KG
(2 persons 80x2=160 kg + tool box 70 kg)

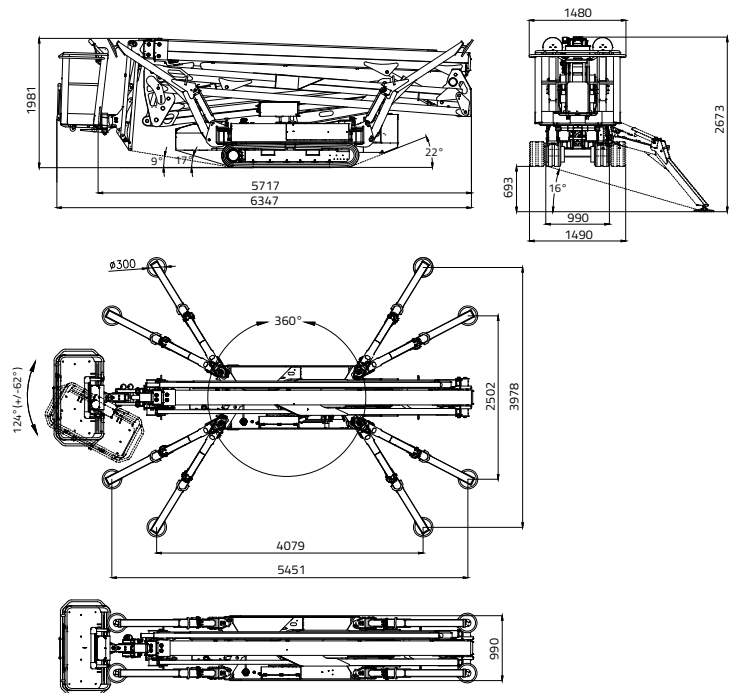

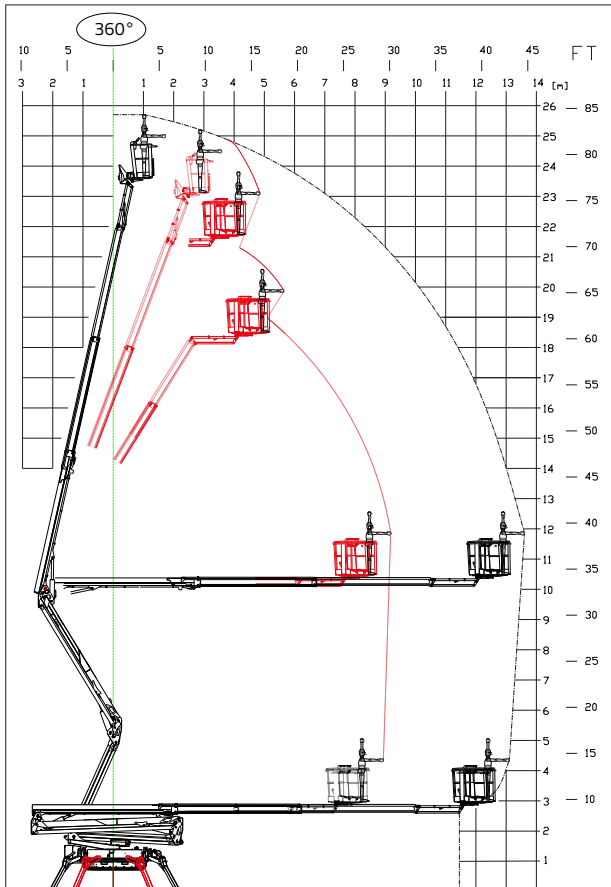

TOTAL AREA

PARTIAL AREA

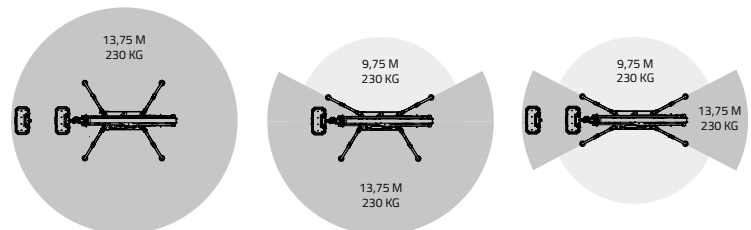
REDUCED AREA



 25,70 m

 13,75 m

 6,34 m

 5,98 m

 1,98 m

 1.335 x 690 x h. 1.100 mm

 124° (+/-62°)

 16° / 28,7%

 990 - 1490 mm

 3124 daN - 4,42 daN/cm²

 Variable stabilization area
4.079 x 3.978 mm
(5.451 x 2.502 mm)

 Automatic set up system IIS std.

 Remote control

 GPRS-GPS

 R.A.H.M.

 Lithium-ion battery pack
7,6 kWh

 Bi-energy (Diesel + Lithium-ion
battery pack)

LL26.14 MK2



DIESEL ENGINE

Brand.....KUBOTA
 Type D902 Autorev
 Pistons no. and displacement..... 898 cm³
 Max gross power
 21,6 HP - 16,1 kW @ 3200 rpm
 Electrical start..... 12 volt

LITHIUM-ION SYSTEM

Lithium-ion powered..... 7,6KWh
 Onboard battery charger
 220V or 110V+-30V 50-60 Hz
 Autonomy 4-5 h
 Recharge time on flat batteries
 4 h (indicative)
 Recharge time to 80% on flat batteries.....
 2 h (indicative)

HYDRAULIC PUMPS

Electric motor no. 2 gear pumps

TRACKED UNDERCARRIAGE

Track tensioner grease-filled
 Rollers no. per side 6 + slide

Translation speed with 2nd auto2speed:

- diesel engine 1,1 - 2 km/h
 - lithium system..... 0,7 - 1,2 km/h

WEIGHT MACHINE diesel engine.....4365 kg

WEIGHT MACHINE lithium system4384 kg

WEIGHT MACHINE bi-energy4560 kg

MAX WIND SPEED 12,5 m/s